

# Data Sheet

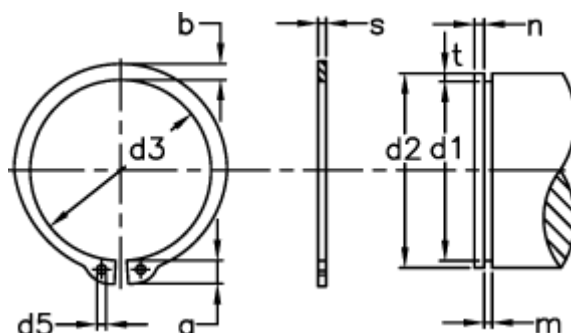

Article number: 0109034  
 Description: Retaining ring AS 18x1.5  
 Spring steel  
 Note: Fitted with ZGA pliers

## Measures



a max	= 5.1	Description	= AS 18	s	= 1.50
AN mm <sup>2</sup>	= 33.0	FN kN	= 5.50	t	= 0.50
B	= 1.56	FRg kN	= 5.8	tol	= -0.11
b	= 2.7	FR kN	= 26.6	tol	= -0.06
d1	= 17.0	g	= 1.5	tol	= +0,10 -0,36
d2	= 18	m min	= 1.60	Tong	= ZGA-2
d3	= 16.5	n abl x 1000	= 43	Weight kg/1000	= 1.54
d5 min	= 2.0	Nominal drive	= 1.8		